

2010 **ALTIMA**

QUICK REFERENCE GUIDE

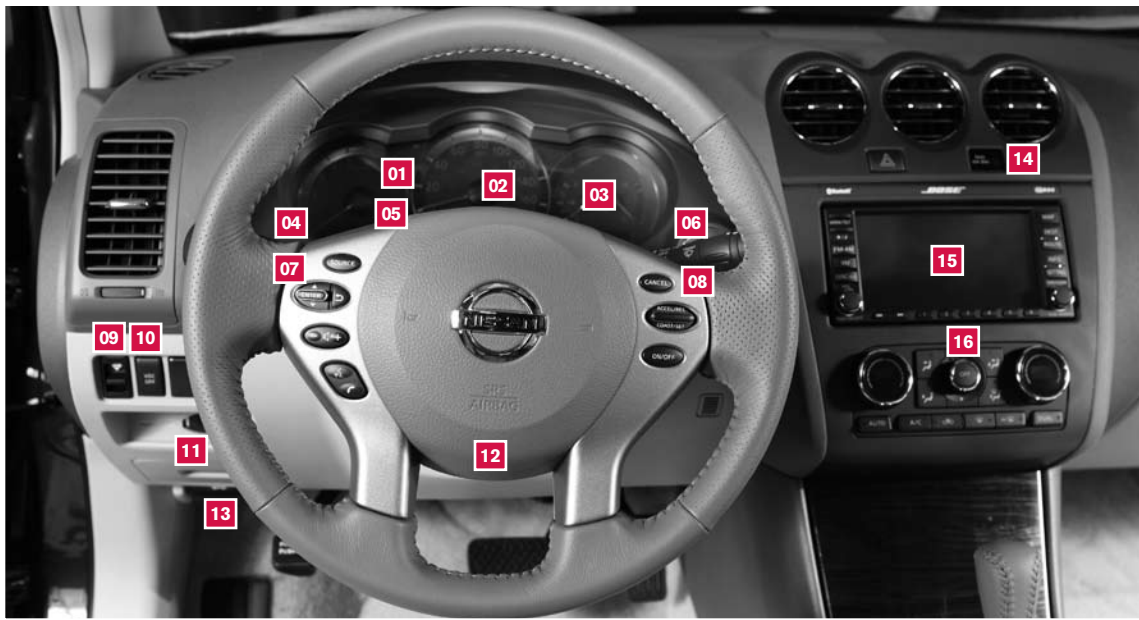



- 01** LOW TIRE PRESSURE WARNING LIGHT
- 02** VEHICLE INFORMATION DISPLAY
- 03** TWIN TRIP ODOMETER/TRIP CHANGE BUTTON
- 04** HEADLIGHT AND TURN SIGNAL CONTROL

- 05** INSTRUMENT BRIGHTNESS CONTROL*
- 06** WINDSHIELD WIPER/WASHER SWITCH
- 07** STEERING WHEEL SWITCH FOR AUDIO CONTROL/BLUETOOTH®
- 08** CRUISE CONTROL

- 09** TRUNK LID OPENER
- 10** VEHICLE DYNAMIC CONTROL (VDC) OFF SWITCH
- 11** INTELLIGENT KEY PORT
- 12** STEERING WHEEL TILT AND TELESCOPIC ADJUSTMENT*

- 13** HOOD RELEASE*
- 14** FRONT PASSENGER AIR BAG STATUS LIGHT
- 15** AUDIO AND NAVIGATION SYSTEM
- 16** AUTOMATIC CLIMATE CONTROL

*See your Owner's Manual for more information.

TABLE OF CONTENTS

NISSAN Intelligent Key™	2
Automatic Door Locks	3
Windshield Wiper/Washer Switch	3
Headlight and Turn Signal Control	4
Steering Wheel Switches for Audio Control/Bluetooth® (if so equipped)	5
Cruise Control	5
Automatic Climate Control (if so equipped)	6
FM/AM/XM®* Radio with CD Player (vehicles with navigation)	8
USB Jack with iPod® Connectivity (if so equipped)	9
Music Box™ Hard Drive Audio System (if so equipped)	10
Bluetooth® Streaming Audio (if so equipped)	11
Vehicle Information Display	11
Clock Set/Adjustment	12
RearView Monitor (if so equipped)	12
Twin Trip Odometer	12
Continuously Variable Transmission (CVT) (if so equipped)	13
6-Speed Manual Transmission (if so equipped)	14
Vehicle Dynamic Control (VDC) Off Switch	14
Front Passenger Air Bag Status Light	14
Tire Pressure Monitoring System (TPMS)	15
Seat Belt Warning Light and Chime	15
Child Safety Rear Door Locks (Sedan only)	15
Fuel-Filler Door Release	15
Fuel-Filler Cap	15
Trunk Lid Cancel Switch (if so equipped)	16
Moonroof Controls (if so equipped)	16
Front Seat Adjustments	16
Passenger Rear Seat Entry (Coupe only)	17
Folding Down the Rear Seats	18
HomeLink® Universal Transceiver (if so equipped)	18
Bluetooth® Hands-free Phone System (vehicles without navigation - if so equipped)	19
Bluetooth® Hands-free Phone System (vehicles with navigation - if so equipped)	22
NISSAN Voice Recognition System (vehicles with navigation - if so equipped)	25
Navigation System (if so equipped)	30

This easy-to-use Quick Reference Guide is intended to help you more fully appreciate some of the unique features and functions of your new vehicle. However, it is not intended to replace your Owner's Manual. The Owner's Manual contains more detailed information to help you better understand the important safety warnings, features, operation and maintenance of your vehicle. All information, specifications, photographs and illustrations in this publication are those in effect at the time of printing. NISSAN reserves the right to change specifications or design without notice and without obligation.

NISSAN INTELLIGENT KEY™

The NISSAN Intelligent Key™ system allows you to lock or unlock your vehicle, open your trunk and start the engine.

NOTE: It is important to make sure the Intelligent Key is with you (that is, in your pocket or purse).

- The operating range of the door and trunk lock/unlock function is approximately 31 in (0.8 m).
- Locking the vehicle - Push any door handle Request Switch (if so equipped) **01** once.
- Unlocking the vehicle - Push any door handle Request Switch (if so equipped) **01** once. The corresponding door will unlock. Push the door handle Request Switch **01** again within 1 minute; all other doors will unlock.



OPENING THE TRUNK

- To open the trunk using the Request Switch (if so equipped), your Intelligent Key must be with you.
- Push the Request/Release Switch (if so equipped) **02** under the trunk handle.
- Lift up on the trunk lid to open the trunk.



STARTING THE ENGINE

- Depress the brake pedal (CVT) or clutch pedal (MT).
- Push the ignition switch to start the engine.



TURNING THE ENGINE OFF

- Shift the shift lever to the P (PARK) position (CVT) or to the N (NEUTRAL) position (manual transmission) and apply the parking brake.
- Push the ignition switch to turn the engine off.

NISSAN INTELLIGENT KEY™ BATTERY DISCHARGE

- If the battery in the Intelligent Key is almost discharged, the guide light of the Intelligent Key port blinks and the Intelligent Key insertion indicator is displayed in the vehicle information display.
- To start the engine under these circumstances, insert the Intelligent Key into the key port in the direction indicated until it latches into place.
- To remove the Intelligent Key from the port, push the ignition switch to turn the engine off and pull the Intelligent Key out of the port.
- The Intelligent Key port does not charge the Intelligent Key battery. If you see the low battery indicator, replace the battery in the Intelligent Key.



AUTOMATIC DOOR LOCKS

- All doors lock automatically when the vehicle speed reaches 15 MPH (24 km/h).
- All doors unlock automatically when the ignition switch is placed in the OFF position.

The automatic unlock function can be deactivated or activated. To deactivate or activate the automatic door unlock system, perform the following procedure:

1. Close all doors.
2. Place the ignition switch in the ON position.
3. Within 20 seconds of performing Step 2, push and hold the power door lock switch to the **U** position (UNLOCK) for more than 5 seconds.
4. When activated, the hazard indicator will flash twice. When deactivated, the hazard indicator will flash once.
5. The ignition switch must be placed in the OFF and ON position again between each setting change.

When the automatic door unlock system is deactivated, the doors do not unlock when the ignition switch is placed in the OFF position. To unlock the door manually, use the inside lock knob or the power door lock switch (driver's or front passenger's side).

WINDSHIELD WIPER/WASHER SWITCH

- The ignition switch must be in the ON position to activate the windshield wipers.
- Move the lever to the following positions to operate the windshield wipers:

1A Intermittent (**INT**) – Front wipers operate intermittently and can be further adjusted by twisting the time control ring **1B**.

02 Low Speed (**LO**) – Continuous low-speed operation of front wipers.

03 High Speed (**HI**) – Continuous high-speed operation of front wipers.

04 Mist (**MIST**) – Lift the lever up for one sweep of the front wipers.

- Pull the lever toward you to activate front washer fluid and several sweeps of the wipers.

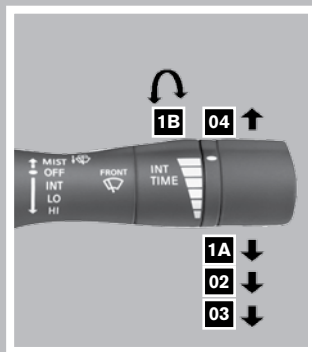

HEADLIGHT AND TURN SIGNAL CONTROL

TO ACTIVATE THE AUTOLIGHT SYSTEM
(if so equipped):

Turn the headlight control switch **01** to the AUTO position to activate the autolight system. The autolight system can:

- Turn the headlights on automatically when it is dark.
- Turn the headlights off automatically when it is light.
- Keep the headlights on for 45 seconds after you turn the ignition switch to OFF and all doors are closed.

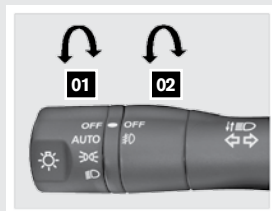

TO DEACTIVATE THE AUTOLIGHT SYSTEM:

- Turn the headlight control switch **01** to the OFF, $\Rightarrow \text{D} \Leftarrow$ or $\Leftarrow \text{D} \Rightarrow$ position.

HEADLIGHT CONTROL SWITCH

- Turn the headlight control switch **01** to the $\Rightarrow \text{D} \Leftarrow$ position to turn on the front parking, tail, license plate and instrument panel lights.
- Turn the headlight control switch **01** to the $\Leftarrow \text{D} \Rightarrow$ position to turn on the headlights. All other lights remain on.

FOG LIGHT OPERATION (if so equipped)

NOTE: The headlights must be on and the low beams $\Leftarrow \text{D} \Rightarrow$ selected for the fog lights to operate.

- Turn the switch (inside collar) **02** to the D position to turn on the fog lights.
- Turn the switch (inside collar) **02** to the OFF position to turn off the fog lights.

HIGH BEAM

- Push the headlight control switch forward **A** to select the high beam function. The blue $\Leftarrow \text{D} \Rightarrow$ indicator light in the instrument panel will illuminate. Pull the headlight switch back to the original position to select the low beam. The blue $\Leftarrow \text{D} \Rightarrow$ indicator light will go out.
- Pull and release the headlight control switch **B** to flash the headlight high beams on and off.

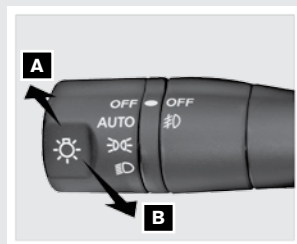

STEERING WHEEL SWITCHES FOR AUDIO CONTROL/ BLUETOOTH® (if so equipped)

■ Press the **SOURCE** button to turn the radio system on.

■ To choose AM, FM or XM® stations (if so equipped), CD/DVD (if so equipped), Music Box™ (if so equipped), USB/iPod® (if so equipped), Bluetooth® Streaming Audio (if so equipped) or AUX press **SOURCE** repeatedly.

■ The tune up or down \blacktriangle switch and **ENTER** button can be used to perform the following:

- Tilt the \blacktriangle switch up or down for less than 1.5 seconds to change to an FM/AM or XM® (if so equipped) preset station.
- Tilt and hold the \blacktriangle switch up or down for more than 1.5 seconds to seek the next or previous AM, FM or XM® (if so equipped) radio station or category.
- Press the **ENTER** button to display a list of AM and FM preset stations (vehicles with navigation).
- Tilt the \blacktriangle switch up or down while playing a CD/DVD (if so equipped), USB/iPod® (if so equipped), Music Box™ (if so equipped) or Bluetooth® Streaming Audio (if so equipped), for less than 1.5 seconds to change tracks.
- Tilt the \blacktriangle switch up or down for more than 1.5 seconds while playing a CD to increase or decrease the folder number (if playing compressed audio files).
- Tilt the \blacktriangle switch up or down for more than 1.5 seconds while playing a DVD (if so equipped) to increase or decrease the title number.
- Press the **ENTER** button to select an item from the DVD display (vehicles with navigation).
- If the vehicle is equipped with a USB Jack, tilt the \blacktriangle switch up or down for more than 1.5 seconds to increase or decrease the folder number.
- If the vehicle is equipped with Music Box™, tilt the \blacktriangle switch up or down for more than 1.5 seconds to increase or decrease the album number or folder.
- Press the **ENTER** button to display the XM® (if so equipped), CD, USB/iPod® (if so equipped), Music Box™ (if so equipped), or AUX menu.

■ Push the + or - control switch to increase or decrease the volume.

*iPod® is a trademark of Apple Inc., registered in the U.S. and other countries.



CRUISE CONTROL

■ To activate the cruise control, push the **ON/OFF** switch. The CRUISE indicator light in the Vehicle Information Display will illuminate.

■ To set cruising speed, accelerate the vehicle to the desired speed, push the **COAST/SET** switch and release. The SET indicator light in the Vehicle Information Display will illuminate.



- To reset at a faster cruising speed, push and hold the **ACCEL/RES** switch. When the vehicle attains the desired speed, release the switch.
- To reset at a slower cruising speed, push and hold the **COAST/SET** switch. Release the switch when the vehicle slows to the desired speed.
- To cancel cruise control, push the **CANCEL** switch or tap the brake pedal. The SET indicator light in the Vehicle Information Display will go out.
- To resume a preset speed, push and release the **ACCEL/RES** switch. The vehicle returns to the last set cruising speed when the vehicle speed is over 25 MPH (40 km/h).
- To turn off cruise control, push the **ON/OFF** switch. Both the CRUISE indicator light and the SET indicator light in the Vehicle Information Display will go out.



AUTOMATIC CLIMATE CONTROL (if so equipped)

01 AUTO BUTTON

- Press the **AUTO** button **01**. Turn the driver's side temperature control dial **02** to the desired temperature. This will allow the fan speed, air flow distribution and temperature to be automatically maintained.
- When **AUTO** is pressed, **AUTO** will illuminate. When **DUAL** **03** is pressed, **DUAL** will illuminate.
- To disable auto mode, press one of the air flow mode control buttons **05**, turn the fan speed control dial **06** or press the front defroster control button **07**.

02 DRIVER'S SIDE TEMPERATURE CONTROL DIAL

Turn the driver's side temperature control dial left for cold air or right for hot air.

03 DUAL BUTTON





Press the **DUAL** button to turn the passenger's side temperature controls on or off. This will allow the passenger's side temperature to be adjusted independently from the driver's side control.

04 PASSENGER'S SIDE TEMPERATURE CONTROL DIAL

Turn the passenger's side temperature control dial left for cold air or right for hot air; doing so will activate dual mode.

05 AIR FLOW MODE CONTROL BUTTONS

Press the buttons to select the following air flow outlets:

-  Air flows from the center and side vents.
-  Air flows from the center, side and foot vents.
-  Air flows mainly from the foot vents.
-  Air flows from the defroster and foot vents.

06 FAN SPEED CONTROL DIAL/OFF BUTTON

Turn the fan speed control dial to the left (slower) or right (faster) to manually control fan speed. Press **OFF** to cancel fan speed operation and turn off climate control operation.

07 DEFROSTING/DEMISTING FRONT AND SIDE WINDOWS

- Press the defroster control button  to turn the system on. The A/C automatically turns on when the defroster mode is selected.
- Turn the driver's side temperature control dial left or right to set the desired temperature.
- To set the defroster on high, turn the fan speed control dial all the way to the right.





08 DEFROSTING REAR WINDOW AND OUTSIDE HEATED MIRRORS (if so equipped)

Push the rear window defroster switch **RR**  on. Push the switch again to manually turn the defroster off. This function automatically turns off in approximately 15 minutes.

09 A/C ON/OFF BUTTON

Press the **A/C** button to manually turn the A/C on or off.

10 AIR RECIRCULATION BUTTON

- Press the air recirculation button  to recirculate air inside the vehicle.
- Press the air recirculation button  again to turn air recirculation off.
- The air recirculation mode can only be selected if the air flow control mode is in the following positions: ,  or .



FM/AM/XM[®]* RADIO WITH CD PLAYER (vehicles with navigation)

01 FM/AM BUTTON

Pressing the **FM/AM** button will change the band to FM1, FM2 or AM radio stations.

02 XM BUTTON*

Press the **XM** button to change the band to XM1, XM2 or XM3 satellite radio stations.

03 DISC/AUX BUTTON

- Press the **DISC/AUX** button to play a CD or DVD loaded into the player.
- Press the **DISC/AUX** button again to switch to Music Box™, USB/iPod®, Bluetooth® Streaming Audio or AUX modes.

NOTE: You may need to adjust the volume on any compatible device plugged into the auxiliary jacks to find the most desired sound level of the audio system.

AUXILIARY INPUT JACKS

The auxiliary input jacks are located inside the center console under the armrest. NTSC compatible devices such as video games, some MP3 players and camcorders can be connected to the auxiliary input jacks. Before connecting a device to the **AUX** jacks, turn the portable device off. With a compatible device connected to the **AUX** input jacks, press the **DISC/AUX** button until the AUX mode appears in the display. The output from the device will be played through the display and audio system. The front display screen will only play videos when the vehicle is in the P (PARK) position and the parking brake is engaged.



AUX Jack Color Codes:

- The red jack is for right channel audio input.
- The white jack is for left channel audio input.
- The yellow jack is for video input.

04 SEEKING BUTTON

- To scan quickly through each broadcasting station, press the seeking button left ◀◀ or right ▶▶.
- For XM[®] radio, press ◀◀ or ▶▶ to switch to the first channel of the previous or next category.
- Press ◀◀ or ▶▶ to change tracks on a CD.
- Press and hold ◀◀ or ▶▶ to fast forward or rewind a track on a CD.

05 STATION SELECT BUTTONS

Twelve stations can be set for the FM band, six for the AM band and eighteen for XM[®]* radio.

- To store a station in a preset you must first select a radio band by pressing the **FM/AM** or **XM** button, then tune to the desired AM, FM or XM[®] station.
- Then press and hold the desired station select button (**1-6**) until the preset number is updated on the display and the sound is briefly muted. The channel indicator will then come on and the sound will resume. Programming is now complete.
- To retrieve a previously set station, select the radio band where the preset was stored, then press the corresponding station select button (**1-6**).

06 TUNE/FOLDER/AUDIO CONTROL KNOB (Bass, Treble, etc.)

- To manually tune the radio, turn the **TUNE/FOLDER** knob right or left. To adjust the Bass, Treble, Balance and Fade, press the **AUDIO** knob until the desired mode appears in the display. Then turn the **TUNE/FOLDER** knob to adjust to the desired level. Once adjusted to the desired level, press the **AUDIO** control knob until the radio or CD display reappears.
- While playing an MP3 CD or a compatible device plugged into the **USB** jack, turn the **TUNE/FOLDER** knob right or left to skip forward or backward through available folders.

07 OPEN/TILT BUTTON

The CD/DVD insert slot is located behind the display screen. To insert a CD, DVD or access the **▲** (eject) button, press the **OPEN/TILT** button on the audio system. The display screen will automatically move down to expose the CD/DVD insert slot. Insert the CD/DVD into the slot with the label side facing up. The CD/DVD will be guided automatically into the slot and begin playing. To return the display screen to its upright position after the CD/DVD is inserted, press the **OPEN/TILT** button again.

TO EJECT A CD

First press the **OPEN/TILT** button **07** on the audio system. Then press the **▲** button to eject a loaded CD or DVD.

PLAY MODE

Play mode allows you to change the play pattern of a loaded CD.

- While a CD is playing, select the “Menu” key on the display, then select the “Play Mode” key and a list of various play patterns will be displayed.

*XM[®] Satellite Radio is only available on vehicles equipped with optional XM[®] satellite subscription.

USB JACK WITH iPod[®] CONNECTIVITY (if so equipped)

The **USB** input jack is located in the center console under the armrest.

- To connect a compatible USB device, open the protective cover on the **USB** jack, and insert the USB device into the jack. When a compatible storage device is plugged into the jack, compatible audio or video files on the storage device can be played through the vehicle's audio system. Video file playback is only available on vehicles with navigation.
- To connect an iPod[®], open the **USB** jack cover, connect the USB end of the cable supplied with your iPod[®] to the jack, then connect the other end of the cable to the iPod[®]. When the ignition switch is in the ACC or ON position, the battery of your iPod[®] (if compatible) will charge while connected to your vehicle.

PLAYING AN iPod®

The interface for iPod® operation shown on the vehicle center display is similar to the iPod® interface.

Select the USB/iPod® mode using one of the following methods:

- Push the **SOURCE** select switch on the steering wheel.
- Press the **DISC/AUX** button.

FOR USB MEMORY (vehicles with navigation):

- After selecting the USB/iPod® mode, select the “Play Movie Contents” key or “Play Audio Contents” key to start playing audio or video files on the device.

SEEKING BUTTON

- Press ◀◀ or ▶▶ for less than 1.5 seconds to skip through tracks.
- Press and hold ◀◀ or ▶▶ for more than 1.5 seconds to rewind or fast forward. When the button is released the audio will play at normal speed.

MUSIC BOX™ HARD DRIVE AUDIO SYSTEM (if so equipped)

The Music Box Hard Drive audio system can store songs from CDs being played. The system has a 9.3 gigabyte (GB) storage capacity and can record up to 200 hours (approximately 2,900 songs).

RECORDING CDS

The system will not record MP3 or WMA files, only regular formatted CDs.

1. Turn the audio system on and insert a CD.
2. Select the “START REC” key. The system starts recording and playing the first track on the CD.



PLAYING RECORDED SONGS

Select Music Box™ using one of the following methods:

- Push the **SOURCE** select switch on the steering wheel.
 - Press the **DISC/AUX** button repeatedly until the center display changes to Music Box™ mode.
- Press ◀◀ or ▶▶ for less than 1.5 seconds to skip through tracks.
 - Press and hold ◀◀ or ▶▶ for more than 1.5 seconds to rewind or fast forward. When the button is released the audio will play at normal speed.
 - Turn the **TUNE/FOLDER** knob right or left to change albums. When playing “All Songs,” the **TUNE/FOLDER** knob changes the track instead of the album.



BLUETOOTH® STREAMING AUDIO (if so equipped)

If you have a compatible Bluetooth® Streaming Audio device, it can be connected to the vehicle's audio system and played through the speakers.

CONNECTING

- Press the **SETTING** button on the instrument panel, then select the "Bluetooth" key.
- Select the "Connect Bluetooth" key and a screen will appear asking if you are connecting the device to use with the hands-free phone system.
- Select "No" when you receive the pop-up question.
- Enter a PIN of your choice. It will be needed by your Bluetooth® Streaming Audio device to complete the connection process.

Note: See the Bluetooth® device's Owner's Manual for more information.

AUDIO OPERATION

- To switch to the Bluetooth® Streaming Audio mode, press the **SOURCE** select switch on the steering wheel or the **DISC/AUX** button repeatedly until the Bluetooth® Streaming Audio mode is displayed on the screen.
- The controls (Menu, Play and Pause) for Bluetooth® Streaming Audio are displayed on the screen.

VEHICLE INFORMATION DISPLAY

When the selection button **01** is pressed, the following modes will display on the screen:

- Setting
- Warnings (if there are any)
- MPG (instant fuel economy)
- MPG/MPH (average fuel economy and speed)
- Time/Miles (elapsed time since last reset)
- Range (average distance to empty)
- Exterior temperature



SETTING MODE

When the setting mode **02** is selected, you are able to set reminders for alerts, maintenance intervals or language displays.

- The ALERT mode allows you to set alerts notifying yourself of time to rest or icy traveling conditions.
- The MAINTENANCE mode allows you to set alerts for the reminding of maintenance intervals for engine oil, oil filter, tires and others.
- The DISPLAY mode allows you to change the unit of measurement (US or metric) display.

CLOCK SET/ADJUSTMENT

NAVIGATION SYSTEM ONLY (if so equipped)

Press the **SETTING** button, and then select the "Clock" key to access the following clock settings:



- On-screen Clock – When this item is turned to ON, a clock is always displayed in the upper right corner of the screen. The clock is automatically adjusted by the GPS system.
- Clock Format – Choose either the 12-hour clock display or the 24-hour clock display.
- Offset (hour) – Adjust the time by increasing or decreasing the hour.
- Offset (minute) – Adjust the time by increasing or decreasing the minutes.
- Daylight Savings Time – Turn this item to ON for daylight savings time application.
- Time Zone – Choose the time zone.

REARVIEW MONITOR (if so equipped)

When the shift lever is moved to the R (REVERSE) position, the monitor display will automatically change to show the area directly behind the vehicle. The colored lines on the display screen indicate approximate distances to objects.



- Red 1.5 ft (0.5 m); Yellow 3 ft (1 m); Green 7 ft (2 m) and 10 ft (3 m).

TWIN TRIP ODOMETER

- The twin trip odometer records the distance of individual trips.
- Press the button **01** to change the display as follows:
Trip A → Trip B → Trip A.
- Press and hold the button **01** for more than 1 second to reset the currently displayed trip odometer to zero.



CONTINUOUSLY VARIABLE TRANSMISSION (CVT)

After starting the engine, fully depress the brake pedal. Move the shift lever out of the P (PARK) position. The CVT can operate in two different automatic drive modes:



- **D (Drive) mode** - When the shift lever is moved to D (Drive), the transmission is in the normal forward automatic driving mode. The position indicator in the meter shows a "D." The D (Drive) mode does not produce a gear change sensation like a traditional automatic transmission.
- **Ds (Drive Sport) mode** - Move the shift lever from D (Drive) to the left into the manual shift gate. The position indicator in the meter shows a "Ds". In Ds (Drive Sport) mode, transmission operation changes to "Sporty" driving shift operation, creating a more aggressive acceleration feeling than the D (Drive) mode and a gear change sensation when the driver accelerates quickly. When the driver selects M (Manual) mode ratio with the shift lever during Ds (Drive Sport) mode operation, the driver must move the shift lever from Ds mode to D mode and back again to re-select Ds (Drive Sport) mode.
 - To cancel the Ds (Drive Sport) mode, return the shift lever to the D (Drive) position. The transmission returns to the normal automatic driving mode.

NOTE: The transmission in your vehicle requires a special fluid available only at your NISSAN dealer. No other fluid will meet the exact requirements of the CVT.

MANUAL SHIFT MODE

- When the shift lever is shifted from D (DRIVE) to the manual shift gate, the transmission enters the manual shift mode.
- When shifting up, move the shift lever to the + (up) side (shifts to higher range).
- When shifting down, move the shift lever to the - (down) side (shifts to lower range).
- In manual shift mode, the position indicator in the meter shows one of the following: "M1," "M2," "M3," "M4," "M5" or "M6."
- In manual shift mode, the transmission automatically shifts down to M1 (FIRST) before the vehicle comes to a stop. When accelerating again, it is necessary to shift to the desired range.
- When canceling the manual shift mode, return the shift lever to the D (DRIVE) position. The transmission returns to the normal driving mode.

6-SPEED MANUAL TRANSMISSION (if so equipped)

LOCK OUT

- In 6-speed manual transmission equipped vehicles, the shift lever is equipped with a Reverse Lock-out feature that prevents accidental selection of R (REVERSE) (instead of 1st gear).





SHIFTING TO REVERSE

- Lift up on the collar just below the shift knob, then move the shift lever left and up into R (REVERSE).

VEHICLE DYNAMIC CONTROL (VDC) OFF SWITCH

The Vehicle Dynamic Control (VDC) system monitors driver inputs and vehicle motion. Under certain conditions, it controls braking and engine output to help the driver in handling the vehicle. VDC does not prevent accidents due to careless or dangerous driving techniques. Always be mindful of vehicle speed and driving conditions. VDC may need to be temporarily shut off if you are trying to free a vehicle stuck in snow or mud.





- Push the Vehicle Dynamic Control (VDC) OFF switch to deactivate the VDC system. The  light will illuminate in the instrument panel gauge area.
- Push the Vehicle Dynamic Control (VDC) OFF switch again to activate the VDC system. The  light will turn off in the instrument panel gauge area.
- The VDC system is active while the vehicle is running until the switch is pushed to turn off.

FRONT PASSENGER AIR BAG STATUS LIGHT

This vehicle is equipped with the Nissan Advanced Air Bag System. Under some conditions, depending on the type of occupant or object detected in the front-passenger's seat by the occupant classification sensor, the front passenger air bag is designed to automatically turn OFF. When the front passenger air bag is OFF, the front passenger air bag status light will illuminate.* For example:



- When the system detects that the front-passenger's seat is occupied by a small adult, child or child restraint as outlined in the Owner's Manual, the  will illuminate to indicate that the front passenger air bag is OFF and will not inflate in a crash.
- When the front-passenger's seat is occupied and the passenger meets the conditions outlined in the Owner's Manual, the  will not illuminate to indicate that the front passenger air bag is operational.

***When the system detects that the front-passenger's seat is unoccupied, the front passenger air bag status light will not illuminate, even though the front passenger air bag is OFF.**

TIRE PRESSURE MONITORING SYSTEM (TPMS)

This system monitors tire pressure. If the low tire pressure warning light illuminates, check the tire pressure in all four tires.

Adjust the low tire pressure to the recommended COLD tire pressure shown on the Tire and Loading Information label located in the driver's door opening. After tire pressures are adjusted, the vehicle will need to be driven at speeds above 16 MPH (25 km/h) to activate the TPMS and turn off the low tire pressure warning light.

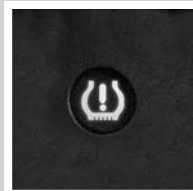

SEAT BELT WARNING LIGHT AND CHIME

- The light and chime remind you to fasten your seat belts. The light illuminates whenever the ignition switch is placed in the ON or START position and remains illuminated until the driver's seat belt is fastened. At the same time, the chime sounds for approximately 6 seconds unless the driver's seat belt is securely fastened.
- With the ignition ON, the seat belt warning light may also illuminate if the front-passenger's seat is occupied with the front-passenger's seat belt unfastened.

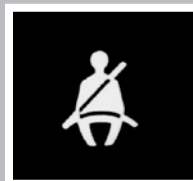

CHILD SAFETY REAR DOOR LOCKS (Sedan Only)

Child safety locks help prevent the rear doors from being opened accidentally, especially when small children are in the vehicle. The child safety lock levers are located on the edge of the rear doors. When the lever is in the LOCK position, the door can only be opened from the outside.



FUEL-FILLER DOOR RELEASE

The fuel-filler door release is located on the floor to the left of the driver's seat.

- To open the fuel-filler door, pull the release up.
- To lock, close the fuel-filler door securely.



FUEL-FILLER CAP

- To tighten, turn the fuel-filler cap clockwise until ratcheting clicks are heard. If the cap is not fully tightened, the **SERVICE ENGINE SOON** light may illuminate.
- If the **SERVICE ENGINE SOON** light illuminates because the fuel cap is loose or missing, tighten or re-install the cap. The **SERVICE ENGINE SOON** light should turn off after a few driving trips.

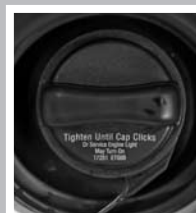

TRUNK LID CANCEL SWITCH (if so equipped)



- When the cancel switch (located inside the glove box) is OFF, the trunk lid cannot be opened with the trunk lid opener (located on the instrument panel), the trunk lid Release/Request Switch (if so equipped) or the NISSAN Intelligent Key™ button.
- It can be opened by using the Emergency Inside Trunk Release.



MOONROOF CONTROLS (if so equipped)



The ignition switch must be in the ON position to operate the moonroof controls.

TILTING THE MOONROOF

- To tilt the moonroof up, push the tilt switch toward the  **01** position.
- To tilt the moonroof down, push the tilt switch toward the  **02** position.



SLIDING THE MOONROOF

- To open the moonroof, push the switch toward the  **02** position.
- To close the moonroof, push the switch toward the  **01** position.
- To open or close the moonroof part way, push the switch in either direction (**01** or **02**) while the moonroof is sliding to stop in the desired position.

FRONT SEAT ADJUSTMENTS

With manual seats (if so equipped):

FORWARD AND BACKWARD

- Pull the center of the bar up **01** under the front of the seat and hold it while you slide the seat forward or backward. Release the bar to lock the seat in position.



SEAT LIFTER (driver's seat, if so equipped)

- Pull up or push down the adjusting lever **02** repeatedly to adjust the seat height.

RECLINING

- Lift the lever **03** on the side of the seat to adjust the seatback forward or backward. Release the lever when you have found a comfortable angle and the seat belt fits properly.

With power seats (if so equipped):

The control lever **01** allows you to make the following adjustments:

- Move the control lever **01** forward or backward to adjust the seat forward or backward.
- Pull up or press down on the front of the control lever **A** to raise or lower the front portion of the driver's seat cushion.
- Pull up or press down on the rear of the control lever **B** to raise or lower the rear portion of the driver's seat cushion.

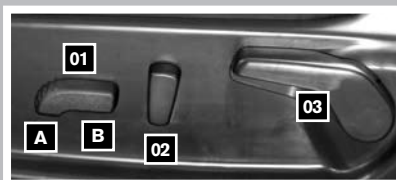

Coupe

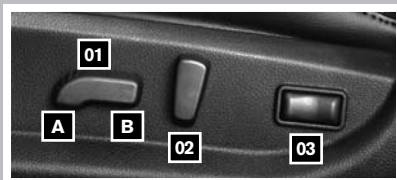

Sedan

RECLINING

- Push the reclining switch **02** forward to move the seatback forward; pull it back to move the seatback backward.

LUMBAR SUPPORT (driver's seat, if so equipped)

- Push or pull the adjusting lever **03** repeatedly to adjust the manual lumbar support.
- Push the lumbar switch **03** to adjust the power lumbar support.

PASSENGER REAR SEAT ENTRY (Coupe only)

FROM INSIDE THE VEHICLE

From the driver's seat:

- Pull the upper seatback release lever **01**, located on the inboard side of the passenger front seat, to the uppermost position and slide the seat forward.



From the back seat:

- Step or push down on the lower seatback release lever **02** located on the backside lower portion of the passenger seat and push the seatback, sliding it forward.



FROM OUTSIDE THE VEHICLE

From the driver's side:

- Pull the upper seatback release lever **01**, located on the outboard side of the driver's front seat. (Return the seatback manually by pushing the seatback rearward.)



From the passenger side:

- Pull the seatback release lever **02** up until the seatback releases, then push the seatback, sliding it forward. (Return the seatback manually by pushing the seatback rearward.)



FOLDING DOWN THE REAR SEATS

FROM INSIDE THE VEHICLE

- The rear seats can be locked using the mechanical key to prevent unauthorized access.
- Open the access cover and press the release button **01** to fold down the center/passenger's side rear seat.
- Reach through the opening and pull on the strap **02** located behind the seat to fold down the driver's side rear seat.

FROM THE TRUNK

- Pull the strap **03** located behind the seat to fold down the center/passenger's side rear seat.
- Pull on the strap **04** located behind the seat to fold down the driver's side rear seat.



HOMELINK® UNIVERSAL TRANSCEIVER (if so equipped)

SYSTEM OPERATING TIPS

- Garage doors, electrical gates, entry doors, etc., will be activated during programming. To avoid injury, make sure that people and objects are clear of all doors or gates during programming. Your vehicle's engine should be turned off while programming the HomeLink® Transceiver.
- To program your HomeLink® Transceiver to operate a garage door, gate, or entry door opener, home or office lighting, you need to be at the same location as the device.

NOTE: Garage door openers (manufactured after 1996) have “rolling code protection.” To program a garage door opener equipped with “rolling code protection,” you will need to use a ladder to get to the garage door opener motor to be able to access the “smart” or “learn” program button.

PROGRAMMING YOUR HOMELINK® UNIVERSAL TRANSCEIVER

(Mirror, Sun Visor or Overhead Console)

1. To begin, press and hold the two outer HomeLink® buttons (to clear the memory) until the indicator light blinks slowly (after 20 seconds). Release both buttons.
2. Position the end of the hand-held transmitter 1-3 in (26-76 mm) away from the HomeLink® surface.
3. Using both hands, simultaneously press and hold both the HomeLink® button you want to program and the hand-held transmitter button. **DO NOT release the buttons until step 4 has been completed.**



4. Hold down both buttons until the indicator light on the HomeLink® flashes, changing from a “slow blink” to a “rapidly flashing blink.” This could take up to 90 seconds. When the indicator light flashes rapidly, both buttons may be released. The rapidly flashing light indicates successful programming. To activate the garage door or other programmed device, press and hold the programmed HomeLink® button - releasing when the device begins to activate.
5. If the indicator light on the HomeLink® blinks rapidly for 2 seconds and then turns solid, HomeLink® has picked up a “rolling code” garage door opener signal. You will need to proceed with the next steps to train the HomeLink® to complete the programming, which may require a ladder and another person for convenience.
6. Press and release the “smart” or “learn” program button located on the garage door opener’s motor to activate the “training mode.” This button is usually located near the antenna wire that hangs down from the motor. If the wire originates from under a light lens, you will need to remove the lens to access the program button.

NOTE: Once you have pressed and released the program button on the garage door opener’s motor and the “training light” is lit, you have 30 seconds in which to perform step 7. Use the help of a second person for convenience to assist when performing this step.

7. Within 30 seconds of pressing and releasing the garage door opener program button, firmly press and release the HomeLink® button you’ve just programmed. Press and release the HomeLink® button up to 3 times to complete the training.
8. Your HomeLink® button should now be programmed. (To program the remaining HomeLink® buttons for additional door or gate openers, follow steps 2-8 only.)



BLUETOOTH® HANDS-FREE PHONE SYSTEM (vehicles without navigation - if so equipped)

With an overhead microphone and sound transmitted through the audio system speakers, the Bluetooth® Hands-free Phone System utilizes Bluetooth® wireless technology and voice recognition to provide hands-free cellular phone communication.

Bluetooth® controls location



SYSTEM OPERATING TIPS

- Close all windows. Surrounding noises may interfere with system operation and performance.
- Press the  button on the steering wheel to activate voice recognition.
- Wait for the tone before speaking.
- Begin speaking a command within 5 seconds of the tone.
- Speak in a clear and natural voice without pausing between words.
- To go back to the previous command, say “Go back” or “Correction.”
- To cancel a voice recognition session, simply wait 5 seconds; say “Cancel,” “Quit” or press the  button.
- To increase or decrease the volume of the voice prompts, press the **VOL** (volume) control switch **+** or **-** on the steering wheel or turn the **POWER/VOLUME** knob on the audio system while the system is responding.

- If the Voice Recognition system does not recognize your voice commands, train the system using the Speaker Adaptation Mode. See your Owner's Manual for detailed information.
- Some commands are not available while the vehicle is in motion.
- The "Help" command can be used in any menu to hear a list of available commands.
- Please refer to the cellular phone manufacturer's Owner's Manual for detailed information regarding your Bluetooth® phone.
- **For recommended phones and detailed instructions, please visit www.nissanusa.com/bluetooth.**

CONNECTING YOUR PHONE

To use the hands-free feature, you need to set up, or connect, the system to recognize your compatible cellular phone(s). Five compatible Bluetooth®-enabled phones can be connected. After setup, the system automatically connects with a connected phone when the ignition is in the ACC or ON position, as long as the phone is on and in the vehicle.

NOTE: Some cellular phones require the user to enable the automatic reconnection feature. Please refer to the cellular phone manufacturer's Owner's Manual for Bluetooth® setup information.

CONNECTING PROCEDURE

NOTE: The vehicle must be stationary when connecting the phone.

1. Press the  button on the steering wheel. The system announces the available commands.
2. Say "Connect Phone."
3. The system acknowledges the previous command and announces the next set of available commands. Say "Add phone."
4. Initiate connecting from the phone.
 - The connecting procedure varies according to each cellular phone model. For detailed connecting instructions and a list of compatible phones, please visit www.nissanusa.com/bluetooth.
 - When prompted for a Passkey code, enter "1234" from the handset. (The Passkey code is assigned by NISSAN and cannot be changed.)
5. Say a name for the phone when the system asks you to provide one. You can give the phone a name of your choice.



MAKING A PHONE CALL

1. Press the  button.
2. After the tone, do one of the following:
 - Say "Call." After the system responds, say the name of the person in the phonebook.
 - Say "Call Phone Number." After waiting for the tone, say [number]. For example, say "Call Phone Number." After waiting for the tone, say "123-456-7891."
 - Say "Redial" to redial the previous phone number.
 - Say "Call Phone Number." After the system responds, say "Special Number" to dial more than 10 digits or special characters.
 - You can say all the digits of a 7- or 10-digit phone number at one time.

- For a 10-digit number, saying the phone number in groups of 3, 3 and 4 digits may improve recognition for some speakers. To use this group dialing method, say only the first 3 digits of the phone number. After the system recognizes the number, it will request the next 3 digits and finally the last 4 digits.
- If a phone number is incorrectly recognized, you can try entering the phone number again using the 3–3–4 group dialing procedure by saying “Correction.”
- When you have finished speaking the phone number wait for the system to repeat it back to you, then say “Dial.”

RECEIVING/ENDING A PHONE CALL

When you receive a phone call, a ring tone sounds through the audio system.

- To accept the call, press the  button. To reject the call, press the  button.
- To hang up the phone at the end of a call or to disconnect during call placement, press the  button.

HOW TO SAY NUMBERS

NISSAN voice recognition permits numbers to be spoken in a variety of ways.

- Say “Zero” or “Oh” for “0.” Example: 1-800-662-6200 – Say “one eight zero zero six six two six two oh oh.”
- Say “pound” for “#.” Say “star” for “*” (available when using the “Call Phone Number” then “Special Number” command and the “Send” command during a call).
- Say “plus” for “+” (available only when using the “Call Phone Number” then “Special Number” command).
- Say “pause” for a 2-second pause.

USING YOUR PHONEBOOK

When a compatible phone is connected to the system, the phonebook is automatically downloaded. This allows you to access your phonebook from the Bluetooth® system to call contacts by name. Up to 1,000 phone numbers will be transferred. To access your phonebook:

1. Press the  button and wait for the tone.
2. Say “Phonebook.”
3. Wait for the tone, then say [a name] or say “List names.” The name must be said exactly as it is entered in your phonebook for the system to recognize it. For example, say “Phonebook” then after the system responds, say “Michelle.”

The phonebook can transfer multiple numbers for each entry. If you select a name with multiple numbers, the system will ask you which number you want to dial.

The system allows for up to 40 voice tags to be recorded. You can record a voice tag for phonebook entries that the system has difficulty recognizing or to directly dial an entry with multiple numbers. To record a voice tag:

1. Press the  button and wait for the tone.
2. Say “Phonebook.”
3. Wait for the tone, then say [a name] or say “List names.” Select the name for which you want to record a voice tag.
4. Say “Record Name.”



BLUETOOTH® HANDS-FREE PHONE SYSTEM (vehicles with navigation - if so equipped)

With an overhead microphone and sound transmitted through the audio system speakers, the Bluetooth® Hands-free Phone System utilizes Bluetooth® wireless technology, a touch-screen and voice recognition to provide hands-free cellular phone communication.

Bluetooth® controls location



SYSTEM OPERATING TIPS

- Close all windows. Surrounding noises may interfere with system operation and performance.
- Press the  button on the steering wheel to activate voice recognition.
- Wait for the “Would you like to access Phone, Navigation, Information, Audio or Help?” prompt and the listening tone before speaking.
- Begin speaking a command within 1.5 seconds of the listening tone.
- To cancel a voice recognition session, press and hold the  button for 2 seconds.
- To increase or decrease the volume of the voice prompts, push the **+** or **-** (volume) control switch on the steering wheel or turn the **VOL** (volume) knob on the audio system while the system is responding.
- Speak in a clear and natural voice without pausing between words.
- The “Help” command will bring up the voice recognition command list.
- Please refer to the cellular phone manufacturer's Owner's Manual for detailed information regarding your Bluetooth® phone.
- For recommended phones and detailed instructions, please visit www.nissanusa.com/bluetooth.

CONNECTING YOUR PHONE

Before using the hands-free feature, you need to set up, or connect, the system to recognize your compatible cellular phone(s). Five compatible Bluetooth®-enabled phones can be connected. After setup, the system automatically connects with a connected phone when the ignition is in the ACC or ON position, as long as the phone is on and in the vehicle.



CONNECTING PROCEDURE

NOTE: The vehicle must be stationary when connecting the phone.

1. Press the **SETTING** button and select the "Bluetooth" key.
2. Select the "Connect Bluetooth" key and a pop up box will appear.
3. Read the information and select "Yes."
4. Initiate connecting from the phone.
 - The connecting procedure for cellular phones varies according to each cellular phone model. For detailed connecting instructions and compatible phones, please visit www.nissanusa.com/bluetooth.
 - The PIN code will appear on the screen (1234 is the default).
5. When the connecting is complete, the screen will return to the Bluetooth® screen.

SETTING UP YOUR PHONEBOOK - ADDING NEW ENTRIES

Up to 40 phone numbers can be stored in the phonebook.

NOTE: The vehicle must be stationary when adding new entries.

1. Press the **SETTING** button and select the "Phone" key, then select the "Vehicle Phonebook" key.
2. Select the "Add New" key at the top of the display. There are different methods to input a phone number. Select one of the following options:
 - "Copy from Call History" to save a number from the Outgoing, Incoming or Missed Calls lists.
 - "Copy from the Handset" to save a number that has been downloaded from your handset to the vehicle.
 - "Enter Number by Keypad" to input the number and name manually.

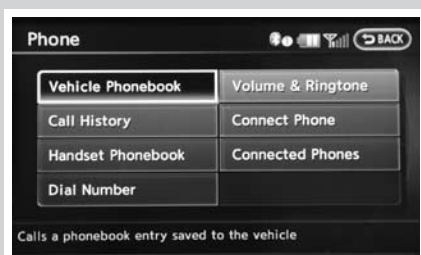

Many phones will support an automatic download of the cellular phone's phonebook. This process may take up to 5 minutes depending on the size of your phonebook. Once the phonebook is downloaded, selecting "Handset Phonebook" will allow you to access your downloaded phonebook (up to 1,000 entries) instead of using the "Vehicle Phonebook" key.



MAKING A PHONE CALL

To make a call, follow the procedure below:

1. Press the  button on the steering wheel. The "Phone" screen will appear on the display.
2. Select "Vehicle Phonebook," "Call History" or "Handset Phonebook."
3. Select the registered person's name from the list. Dialing will start.



RECEIVING/ENDING A PHONE CALL

- There are no voice commands for receiving or ending a phone call.
- To accept the call, press the  button on the steering wheel or select the "Answer" key. To reject the call, select the "Reject Call" key. To hang-up, press the  button or select the "Hang-Up" key.
- Pressing the  button during a connected phone call will allow you to send digits and special characters. After speaking the desired digits, press the **ENTER** button to send the recognized information.



HOW TO SAY NUMBERS

The system provides two commands for entering and dialing a phone number: "DIAL" and "INTERNATIONAL CALL." The "DIAL" command is used for domestic phone numbers up to 10-digits in length, starting with the area code. The "INTERNATIONAL CALL" command is used when more than 10-digits need to be dialed or when special characters are required, such as: *, # or +. When using these two commands, please follow the phone digit speaking rules below:

- Only single digits 0 (zero) to 9 (nine) can be spoken.
- When saying the phone number 800-662-6200, the system will accept "eight hundred" in addition to "eight zero zero" or "eight oh oh." 500, 700 and 900 are also supported.
- The long-distance calling prefix "1" is not required when making a call.

"DIAL" COMMAND ONLY

- You can say all the digits of a 7- or 10-digit phone number at one time.
- For a 10-digit number, saying the phone number in groups of 3, 3 and 4 digits may improve recognition for some speakers. To use this group dialing method, say only the first 3 digits of the phone number. After the system recognizes the number, it will request the next 3 digits and finally the last 4 digits.
- If a phone number is incorrectly recognized, you can try entering the phone number again using the 3-3-4 group dialing procedure by saying, "CHANGE NUMBER."

"INTERNATIONAL CALL" COMMAND ONLY

- You can say the entire phone number at once or in groups of any digit length.
- For *, # and +, say "STAR," "POUND" or "PLUS," respectively.



NISSAN VOICE RECOGNITION SYSTEM (vehicles with navigation - if so equipped)

Voice Recognition allows hands-free operation of the phone, navigation, vehicle information and audio systems as a default setting (Standard Mode). Available commands are announced by the system and shown on the display. You can complete your desired operation by following the instructional prompts given by the system. The system will indicate when you can speak a command by sounding a tone.

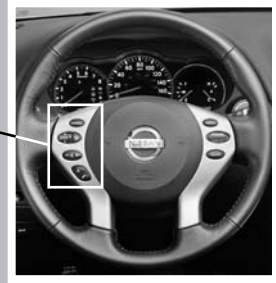
Voice Recognition controls location





When the ignition switch is placed in the ON position, NISSAN Voice Recognition is initialized, which takes a few seconds. When completed, the system is ready to accept voice commands.

To use voice recognition, push the  (TALK) switch located on the steering wheel. If you press the  switch before the system is ready the display will show the message, "System not ready."

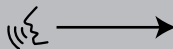
After pushing the  switch, the system responds with, "Would you like to access Phone, Navigation, Information, Audio or Help?" The screen also changes and shows the available commands to speak. After the tone, say one of the command choices. The system will then proceed to the next step.



"Would you like to access Phone, Navigation, Information, Audio or Help?"

After the tone sounds and the icon on the screen changes from  to , say:

"Phone"

or "Navigation"

or "Information"



"Audio"

or

"Help"





Saying "Help" will display the User Guide explained later in this guide. Continue listening to the prompts and respond after the tone until the desired operation is completed. Remember to wait for the tone before speaking. For proper recognition of phone numbers and street names, please review the operating tips below. The commands shown in the menus above are available in Standard Mode. To access an expanded list of commands, please see "Alternate Command Mode" in this guide.

SYSTEM OPERATING TIPS

Before Starting

To get the best possible performance out of the Voice Recognition system, observe the following:

- The interior of the vehicle should be as quiet as possible. Close the windows to minimize the surrounding noises.
- Wait until the tone sounds before speaking a command.
- Speak in a natural conversational voice with minimal pauses between words.
- If you want to repeat a step or if the system incorrectly recognizes your command, push the  switch on the steering wheel or select the " BACK" key on the display.
- If the system does not recognize your command, please repeat the command again. However, avoid raising the volume of your voice or slowing down your speech unless the system prompts you to do so. Speaking too slowly reduces recognition accuracy.
- To give commands quickly, press the  switch to interrupt the voice guidance.

How to speak phone numbers

The system provides two commands for entering and dialing a phone number: "DIAL" and "INTERNATIONAL CALL." The "DIAL" command is used for domestic phone numbers up to 10 digits in length starting with the area code. The "INTERNATIONAL CALL" command is used when more than 10 digits need to be dialed or when special characters are required such as *, #, or +. When using these two commands, please follow the phone digit speaking rules below:

- Only single digits 0 (zero) to 9 (nine) can be spoken.
- Speak digits at a normal pace. Speaking too slowly reduces recognition accuracy.
- When saying the phone number 800-662-6200, the system will accept "eight zero zero" or "eight oh oh." 500, 700 and 900 are also supported.
- The long-distance dialing prefix "1" is not required when making a call.

"DIAL" COMMAND ONLY

- You can say all the digits of a 7- or 10-digit phone number at one time.
- For a 10-digit number, saying the phone number in groups of 3, 3 and 4 digits may improve recognition for some speakers. To use this group dialing method, say only the first 3 digits of the phone number. After the system recognizes the 3 three digits, it will request the next 3 digits and finally the last 4 digits.
- If a phone number is incorrectly recognized, you can try entering the phone number again using the 3-3-4 group dialing procedure by saying, "CHANGE NUMBER."

"INTERNATIONAL CALL" COMMAND ONLY

- You can say the entire phone number at once or in groups of any digit length.
- For *, # and +, say "STAR," "POUND" or "PLUS," respectively.

VOICE COMMAND USAGE

Making a Phone Call

1. Push the  switch on the steering wheel. The system responds with, "Would you like to access Phone, Navigation, Information, Audio or Help?" The commands are also displayed on the screen.



2. After the tone, say "PHONE."

3. The system then displays the five available phone commands and says: "Please say Dial Number, Vehicle Phonebook, Handset Phonebook, Call History or International Call."

4. After the tone, do one of the following:

- Say "DIAL NUMBER" to dial a 7- or 10-digit phone number only. Then, follow the prompts to begin saying the phone number starting with the area code. After the phone number has been recognized, say "DIAL." If incorrect, say "CHANGE NUMBER."
- Say "VEHICLE PHONEBOOK" to say the voice tag of one of up to 40 phone numbers you have stored in the vehicle.
- Say "HANDSET PHONEBOOK" to say the name of one of up to 1,000 contacts downloaded from your phone handset. (Note: The order of contact information (first name, last name) transferred depends on the phone manufacturer. The name must be spoken as shown in the Handset Phonebook list.)
- Say "CALL HISTORY" to select between incoming, outgoing and missed call lists.
- Say "INTERNATIONAL CALL" to dial a number longer than 10 digits.

Receiving/Ending a Phone Call

- There are no voice commands for receiving or ending a phone call.
- To accept the call, push the  switch on the steering wheel or select the "Answer" key on the display. To reject the call, select the "Reject Call" key. To hang-up, push the  switch or select the "Hang-Up" key.
- Pushing the  switch during a connected phone call will allow you to send digits and special characters. After speaking the desired digits, press the **ENTER** button to send the recognized information.



Setting a Destination to a Street Address

1. Push the  switch on the steering wheel.
2. The system responds with: "Would you like to access Phone, Navigation, Information, Audio or Help?"
3. Say "NAVIGATION."
4. The system announces, "Please say Home, Address, Places, Address Book or Previous Destinations."
5. Say, "ADDRESS."



6. Say the name of the state, "CALIFORNIA."



7. Say the name of the city, "GARDENA."



8. Say the name of the street, "FIGUEROA."



9. Say the house number.



- To begin route guidance say, "CALCULATE ROUTE." To confirm the destination location on the map before proceeding say, "SHOW MAP."



- To improve recognition accuracy of street names, say the entire street name including Boulevard, Way, North, South, Road, etc., if it is known.
- If a list of choices appears, please say the number from the displayed list.
- If you don't know the house number when asked, say "NO HOUSE NUMBER," and the system will use a default location on the street.

Setting a Destination to a Place

- After saying "NAVIGATION," the command "PLACES" allows you to select a nearby place category. The category selection will show the 5 nearest places in the chosen category.
- To customize this list, please refer to the NAVIGATION SETTINGS section of your Navigation Owner's Manual.



DISPLAYING THE USER GUIDE TUTORIALS

You can confirm how to use voice recognition by accessing a simplified User Guide. The guide contains basic instructions for using voice recognition and tutorials for several voice commands.

- Press **INFO**.
- Select "Voice Recognition."
- Select "User Guide."
- Select the desired topic to begin the tutorial.



ALTERNATE COMMAND MODE

For advanced operation, you can change to an Alternate Command Mode that expands the available list of commands. When this mode is active, all of the Phone, Navigation, Information, Audio and Help commands can also be spoken after pushing the  switch without first having to say the type of command (e.g., Phone).

- Press **SETTING**.
- Select "Others."
- Select "Voice Recognition."
- Select "Alternate Command Mode."
- To confirm the new mode, select "OK."

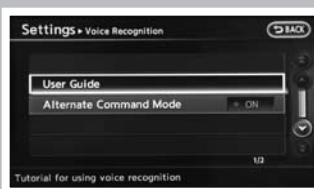

6. Verify that the screen changes to the one shown here.

- "Alternate Command Mode ON" is shown below the displayed commands.
- Review the expanded command list by now using the voice command "Command List." You can also access the list by pressing the **INFO** button. Then, select "Others," select "Voice Recognition," then select "Command List."
- To display the command list main menu press the \mathbb{W} , wait for the tone, then say, "Help."
- Review the new command lists in the Owner's Manual as some commands have been replaced.



Speaker Adaptation

When Alternate Command Mode is selected, it is recommended that the Speaker Adaptation procedure be performed, to train the system to your voice. Speaker Adaptation allows up to three users to train the system to improve recognition accuracy. By repeating a number of commands, the users can create a voice model of their own voice that is stored in the system.



NAVIGATION SYSTEM (if so equipped)

GETTING STARTED

The Navigation System starts up when the ignition switch is placed in the ACC or ON position. To help ensure safe driving, some functions are grayed out, or muted, while driving. Park the vehicle in a safe location and then operate the Navigation System.

NAVIGATION DISPLAY SCREEN

- Displays navigation features and map.



DISABLED WHILE DRIVING

- Not all features can be manually operated while the vehicle is in motion. The text for these restricted features turns from white to gray and cannot be selected. Alternatively, the voice recognition system may have a related command that can be used at anytime.



DAY/NIGHT BUTTON

- Press the ☀/🌙 **OFF** button **01** to switch between the day screen (bright) and the night screen (dark). Within 10 seconds of pressing the ☀/🌙 **OFF** button **01**, you can adjust the brightness of the map display screen by pressing the ◀ or ▶ directional keys.

USING THE TOUCH-SCREEN

- To maneuver around the navigation display screen, touch the screen to select the item or key displayed. To move around the map screen, touch and hold to scroll around.



SETTING BUTTON

- Press the **SETTING** button **06** to change or set navigation preferences.



DEST (DESTINATION) BUTTON

- Press the **DEST** button **03** to display the address book and alternative ways of programming a destination.



MAP BUTTON

- Press the **MAP** button **02** to display the current location map screen.

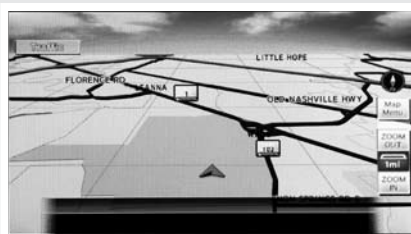

INFO BUTTON

- Press the **INFO** button **05** to set or view various information that is helpful for using the vehicle safely and comfortably.

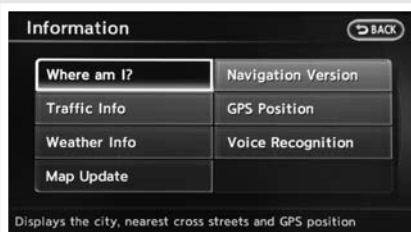

ROUTE BUTTON

- Press the **ROUTE** button **04** to display various ways to modify the route to a destination.



ZOOM OUT/IN KEYS

- Select the "Zoom Out" key or the "Zoom In" key to increase or decrease the scale of the map display.



BACK KEY

- Select the "**BACK**" key to return to the previous function shown on the navigation display.



SWITCHING THE MAP VIEW

- Press the **MAP** button **02** . The current location map screen is displayed.
- Select the “Map Menu” key.
- Select the “Map View” key.

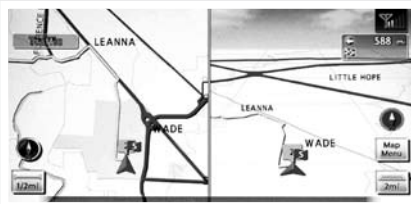

- Select the “Change View” key.
- Select either one of the “2D” keys or one of the “Birdview (3D)” keys to select the map view. Press the **MAP** button **02** or select the “**BACK**” key to accept the changes.

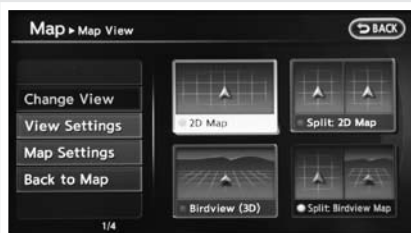

2D

- Displays the map in a 2-dimensional environment similar to a road map.

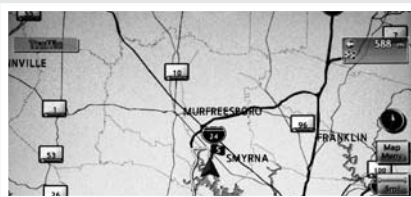

BIRDVIEW™

- Displays the map in an elevated or 3-dimensional perspective.

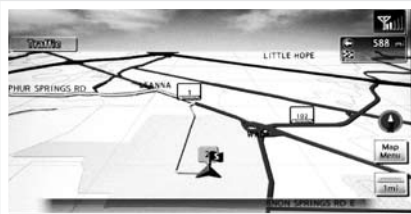

SELECTING A MENU SCREEN

1. To select a preferred menu key, touch the corresponding key on the screen.
2. Depending on the key you selected, a detailed menu screen, a character input screen or a setting screen, etc., is displayed. On the screen displayed, make adjustments, input information, etc., accordingly.
3. Select the “↶ BACK” key to return to the previous screen without applying any changes; in some cases, selecting the “↶ BACK” key will accept the changes you made.
4. Press the **MAP** button **02** to return to the current location map.

NOTE: Depending on the menu selected, pressing the **MAP** button **02** may not return you to the current location map screen.

STORING YOUR HOME IN YOUR ADDRESS BOOK

- Press the **DEST** button **03**.
- Select the “Home (Add New)” key. If you have already stored your home this key may not appear.
- When you select the “Home (Add New)” key, a confirmation message is displayed. Select the “Yes” key.

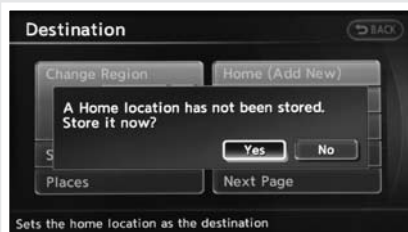

- Select the “Street Address” key. A character input screen is displayed.
- Enter the street number of your home, then select the “OK” key.



- Enter your street name, select the ‘List’ key. The map screen is displayed.



- Your home is displayed at the center of the map.



- A confirmation message is displayed and the system sets your home as the destination. Select the "OK" key.
- Press the **MAP** button **02** to return to the current location map screen.



SETTING A STREET ADDRESS AS A DESTINATION

- Press the **DEST** button **03**.
- Select the "Street Address" key. A character input screen is displayed.
- Enter the house number; when finished select the "OK" key. If you do not know the house number, select the "No House #" key.



- Enter the name of the street. After finishing the entry, select the "List" key. A list of possible street addresses is displayed.



- Select the correct address of the destination from the list. You might need to select the “Up” or “Down” key to find the preferred street address key.

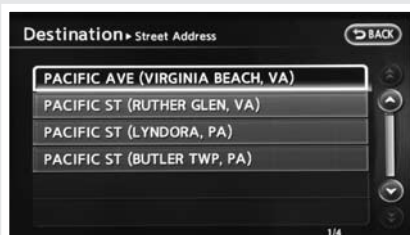

- The selected destination will be briefly displayed before showing the entire route. Select the “Start” key after confirming the displayed route is acceptable. The voice guidance will begin shortly.



MOVING AROUND WITHIN A MAP

You can manually move across the map to view the surrounding area or to view a preferred location.

- Touch the screen in the direction that you want to move across the map. Once you begin moving on the map, the cross pointer appears.
- Press the **MAP** button **02** or select the “**BACK**” key to return to the current location map screen. The cross pointer disappears.



SETTING A PLACE AS A DESTINATION

- Press the **DEST** button **03**.
- Select the “Places” key.



- Select the preferred nearby category from the list.



- Select the preferred destination from the list. The position of the selected location is displayed on the right side of the screen.

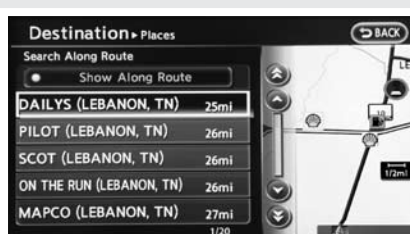

NOTE: A maximum of 100 facilities can be displayed on the list screen. If the suggested route is already set, by selecting the "Show Along Route" key, the system displays only the facilities located along the route.

- The selected destination will be briefly displayed before showing the entire route. Select the "Start" key after confirming the displayed route is acceptable. The voice guidance will begin shortly.



ROUTE GUIDANCE

While following the route guidance, press the **MAP** button **02** to change from a split screen to a full screen view of the map.

By default, the split screen will show a turn list and possibly freeway exits. When approaching an intersection or freeway junction, a second split map screen is available to show the details of that intersection or junction.





Nissan, the Nissan Brand Symbol, "SHIFT_" tagline,
Z and Nissan model names are Nissan trademarks.
© 2009 Nissan North America, Inc.
QR0E-0L32U1
Printing: December 2009 (12)

